

331

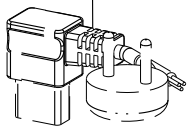

304

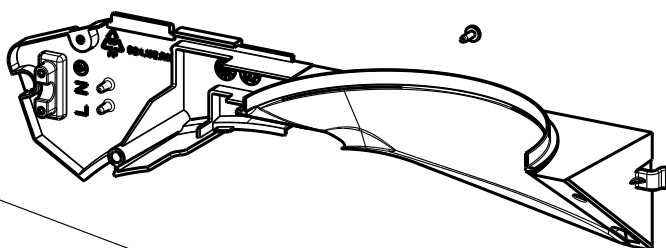

303

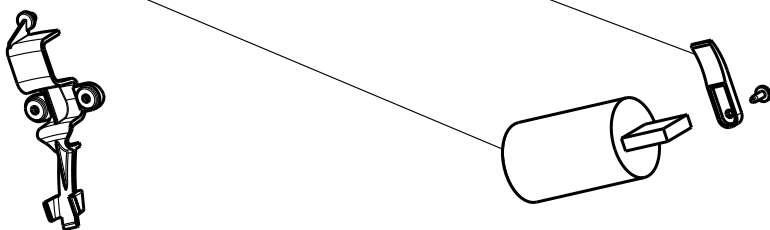

301

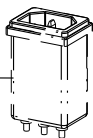

330

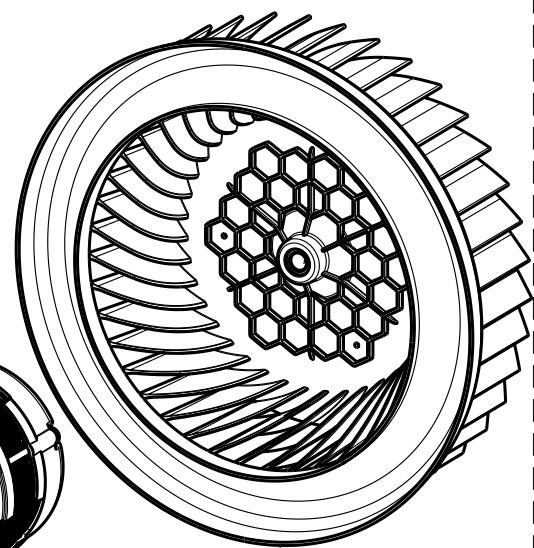
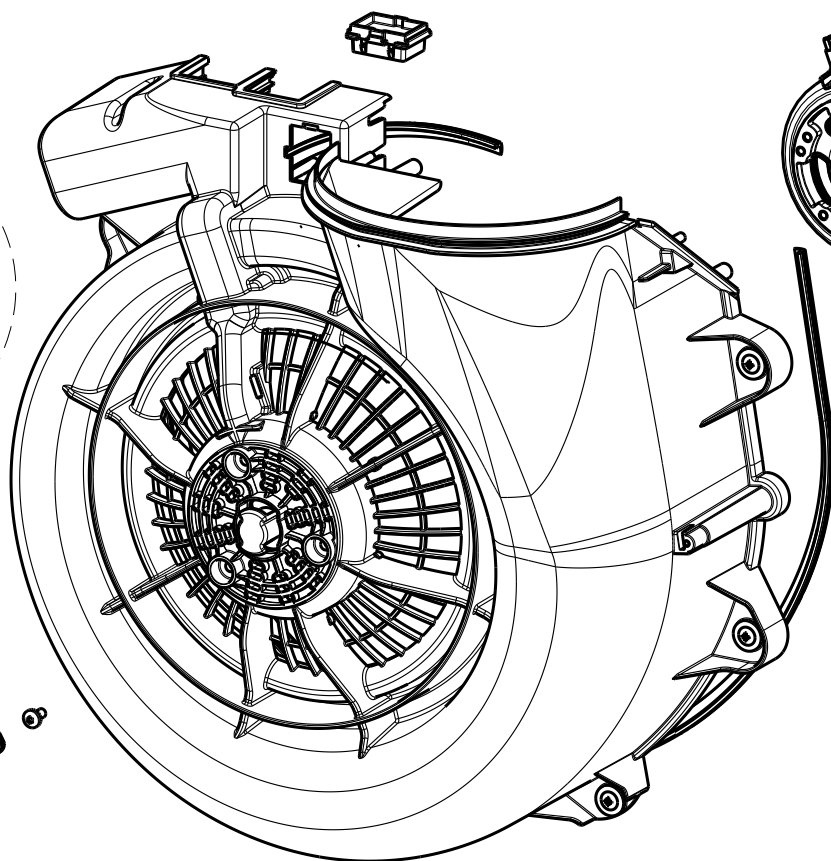
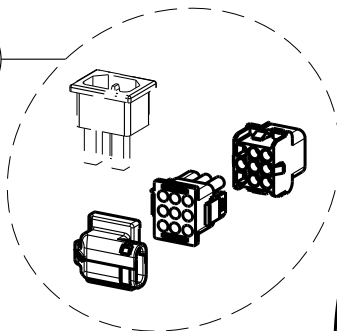

306

399

Created by Galassi, Raffaele	
Denomination EXPLODED DRAWING M8	
Rif. 300	
Modif.by tcimport	
Approved by Galassi, Raffaele	
Approval date 11-Dec-2017	
Doc. status Released	
Drawing N. D24_753	Rev 01