

DF

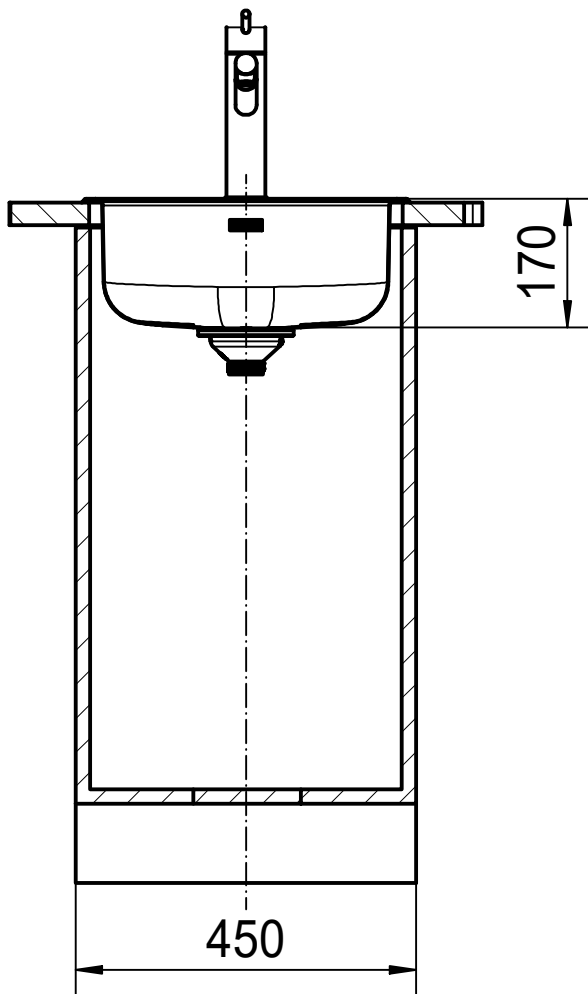

Drawing No.	20257852_01	Revision	-
Drawn Date	26.09.2023		
<small>These drawings and specifications are the property of Franke Technology and Trademark Ltd. and shall not be reproduced, copied or transferred to any third party without the prior written permission of Franke Technology and Trademark Ltd., Hergiswil, Switzerland</small>			



ROX 610/110-38 SI
Installing Document

Sheet	Sheets
1	11

DS

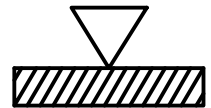
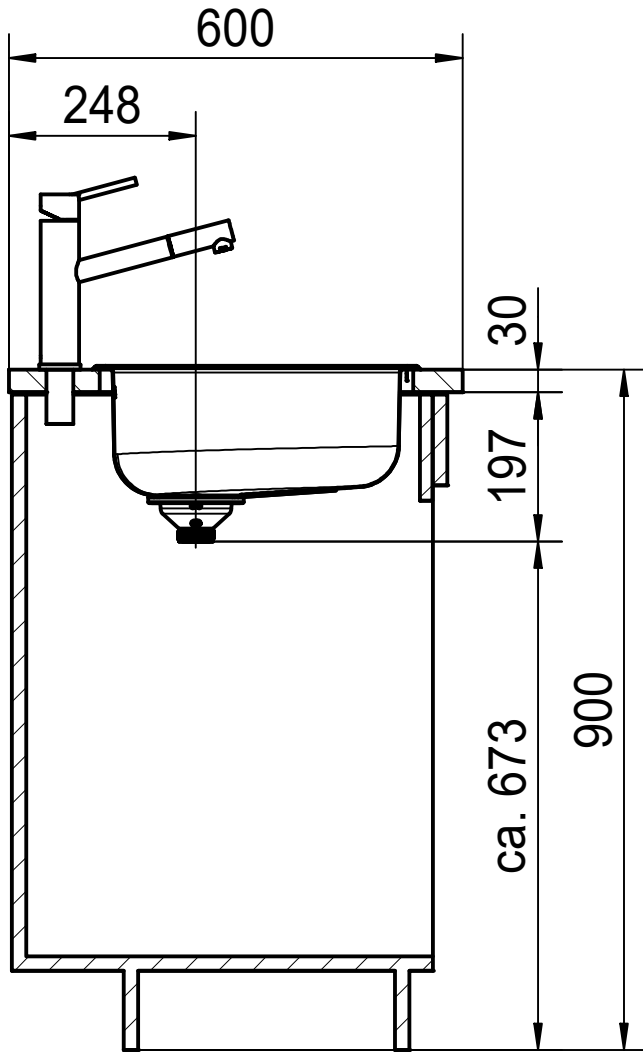

Drawing No.	20257852_01	Revision	-
Drawn Date	26.09.2023		
<small>These drawings and specifications are the property of Franke Technology and Trademark Ltd. and shall not be reproduced, copied or transferred to any third party without the prior written permission of Franke Technology and Trademark Ltd., Hergiswil, Switzerland</small>			



ROX 610/110-38 SI
Installing Document

Sheet	Sheets
2	11

CO

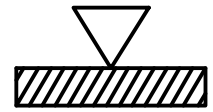
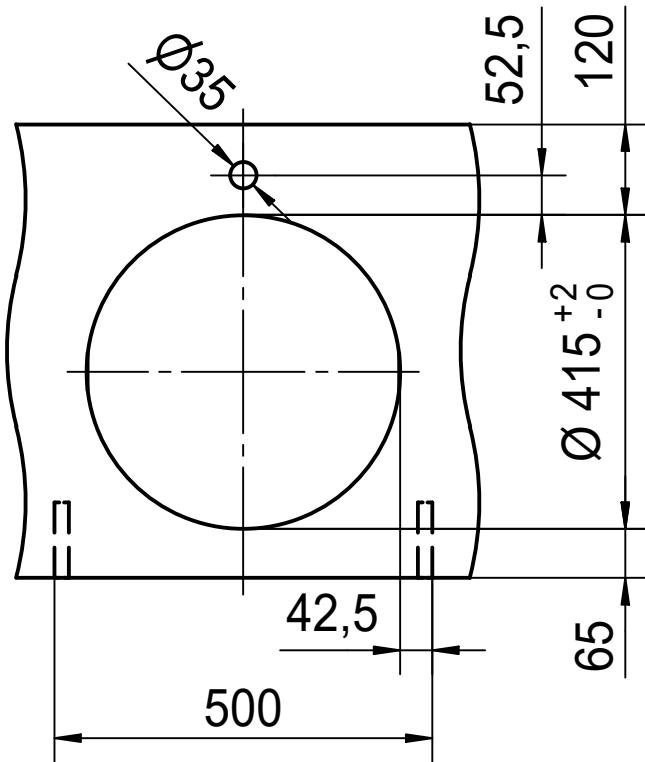

Drawing No.	20257852_01	Revision	-
Drawn Date	26.09.2023		
<small>These drawings and specifications are the property of Franke Technology and Trademark Ltd. and shall not be reproduced, copied or transferred to any third party without the prior written permission of Franke Technology and Trademark Ltd., Hergiswil, Switzerland</small>			



ROX 610/110-38 SI
Installing Document

Sheet	Sheets
3	11

CNC

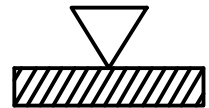
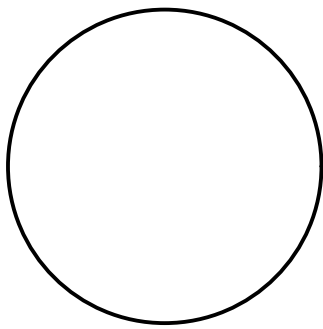

Drawing No.	20257852_01	Revision	-
Drawn Date	26.09.2023		
<small>These drawings and specifications are the property of Franke Technology and Trademark Ltd. and shall not be reproduced, copied or transferred to any third party without the prior written permission of Franke Technology and Trademark Ltd., Hergiswil, Switzerland</small>			



ROX 610/110-38 SI
Installing Document

Sheet	Sheets
4	11

DT

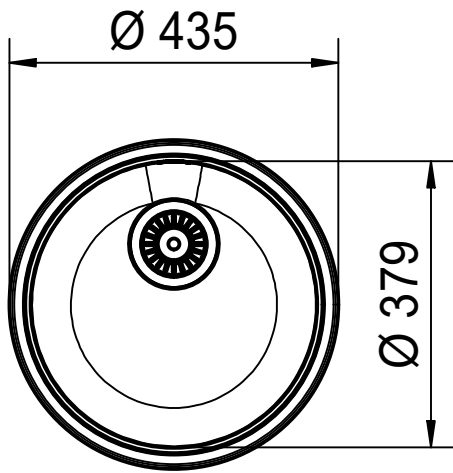

Drawing No.	20257852_01	Revision	-
Drawn Date	26.09.2023		
<small>These drawings and specifications are the property of Franke Technology and Trademark Ltd. and shall not be reproduced, copied or transferred to any third party without the prior written permission of Franke Technology and Trademark Ltd., Hergiswil, Switzerland</small>			



ROX 610/110-38 SI
Installing Document

Sheet	Sheets
5	11

ISO

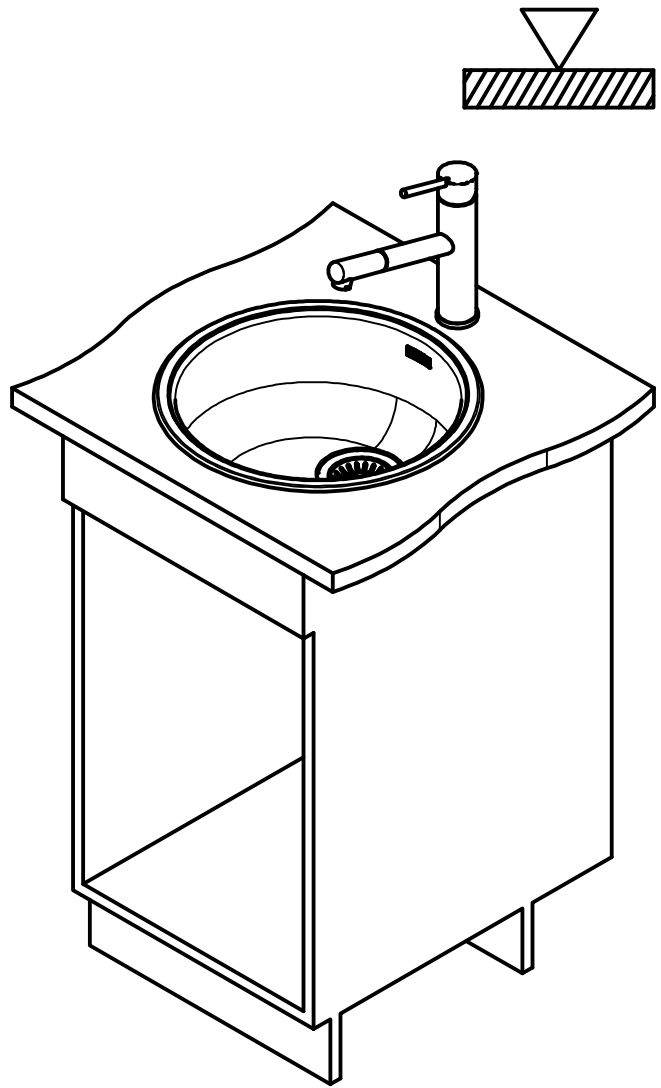

Drawing No.	20257852_01	Revision	-
Drawn Date	26.09.2023		
<small>These drawings and specifications are the property of Franke Technology and Trademark Ltd. and shall not be reproduced, copied or transferred to any third party without the prior written permission of Franke Technology and Trademark Ltd., Hergiswil, Switzerland</small>			



ROX 610/110-38 SI
Installing Document

Sheet	Sheets
6	11

DF

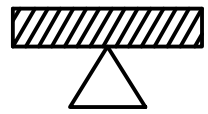
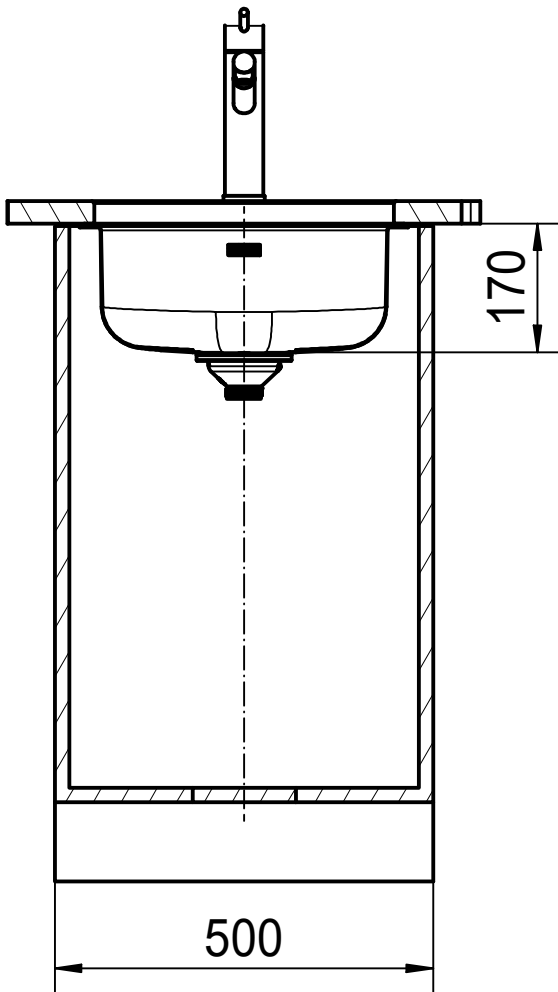

Drawing No.	20257852_01	Revision	-
Drawn Date	26.09.2023		
<small>These drawings and specifications are the property of Franke Technology and Trademark Ltd. and shall not be reproduced, copied or transferred to any third party without the prior written permission of Franke Technology and Trademark Ltd., Hergiswil, Switzerland</small>			



ROX 610/110-38 SI
Installing Document

Sheet	Sheets
7	11

DS

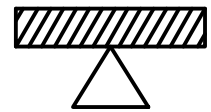
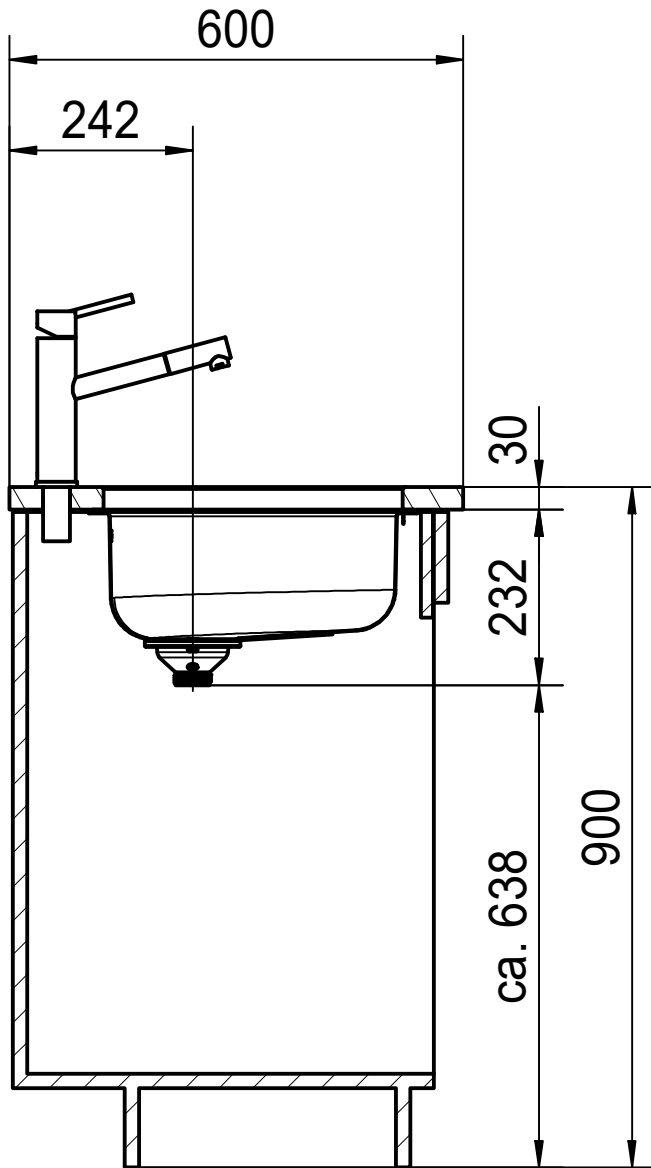

Drawing No.	20257852_01	Revision	-
Drawn Date	26.09.2023		
<small>These drawings and specifications are the property of Franke Technology and Trademark Ltd. and shall not be reproduced, copied or transferred to any third party without the prior written permission of Franke Technology and Trademark Ltd., Hergiswil, Switzerland</small>			



ROX 610/110-38 SI
Installing Document

Sheet	Sheets
8	11

CO

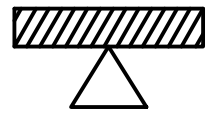
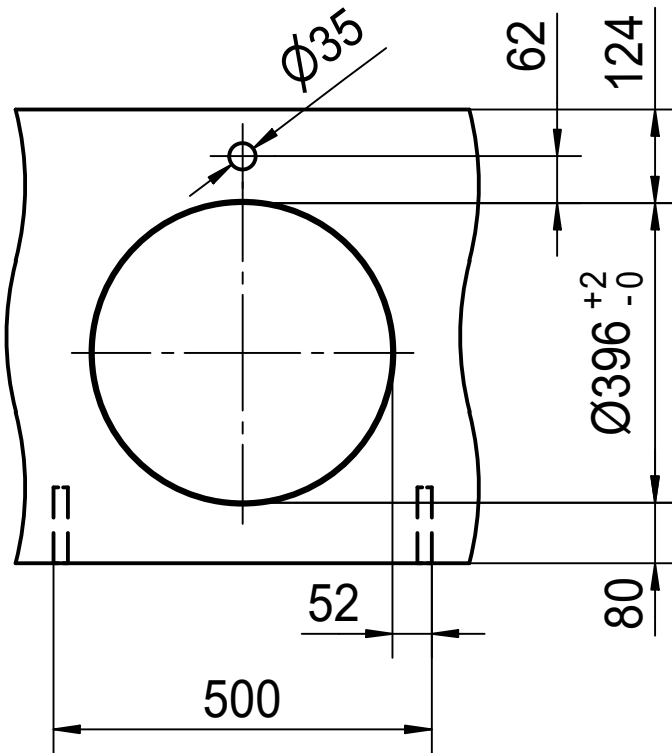

Drawing No.	20257852_01	Revision	-
Drawn Date	26.09.2023		
<small>These drawings and specifications are the property of Franke Technology and Trademark Ltd. and shall not be reproduced, copied or transferred to any third party without the prior written permission of Franke Technology and Trademark Ltd., Hergiswil, Switzerland</small>			



ROX 610/110-38 SI
Installing Document

Sheet	Sheets
9	11

CNC

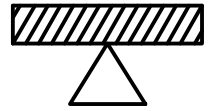
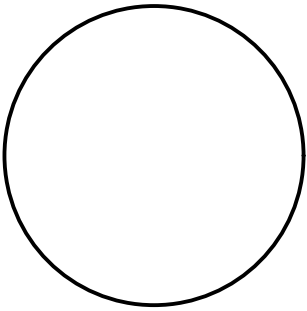

Drawing No.	20257852_01	Revision	-
Drawn Date	26.09.2023		
<small>These drawings and specifications are the property of Franke Technology and Trademark Ltd. and shall not be reproduced, copied or transferred to any third party without the prior written permission of Franke Technology and Trademark Ltd., Hergiswil, Switzerland</small>			



ROX 610/110-38 SI
Installing Document

Sheet	Sheets
10	11

ISO

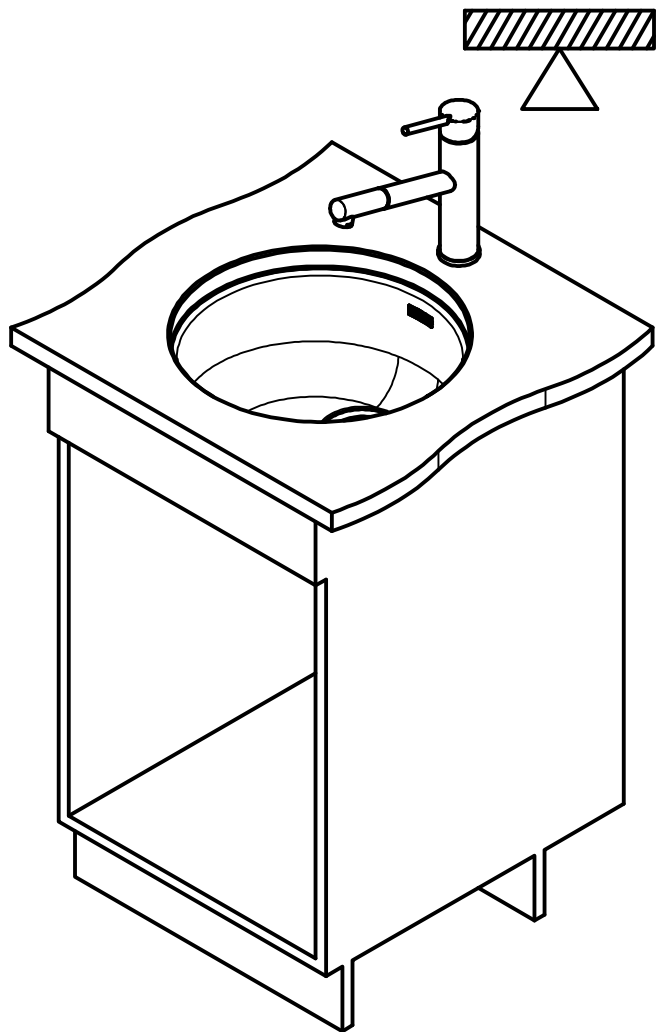

Drawing No.	20257852_01	Revision	-
Drawn Date	26.09.2023		
<small>These drawings and specifications are the property of Franke Technology and Trademark Ltd. and shall not be reproduced, copied or transferred to any third party without the prior written permission of Franke Technology and Trademark Ltd., Hergiswil, Switzerland</small>			



ROX 610/110-38 SI
Installing Document

Sheet	Sheets
11	11