

DF

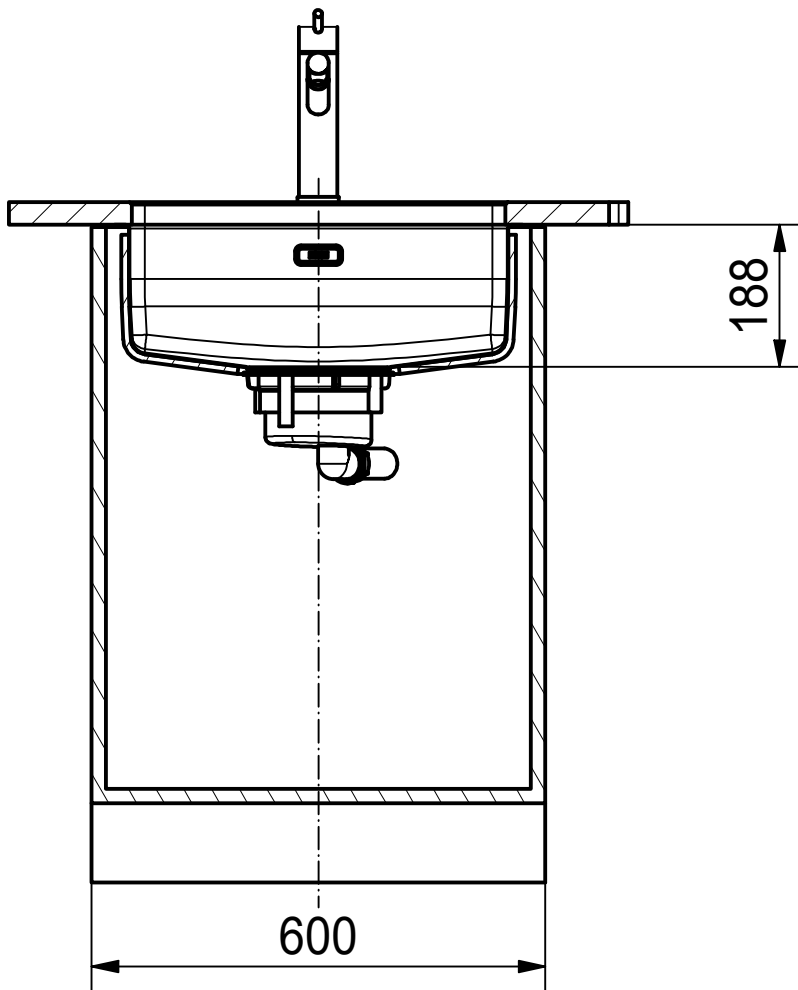

Drawing No.	20247047_01	Revision	-
Drawn Date	12.01.2023		
These drawings and specifications are the property of Franke Technology and Trademark Ltd., Hergiswil, Switzerland.			



MQX 110-50 SI
Installing Document

Sheet	Sheets
1	6

DS

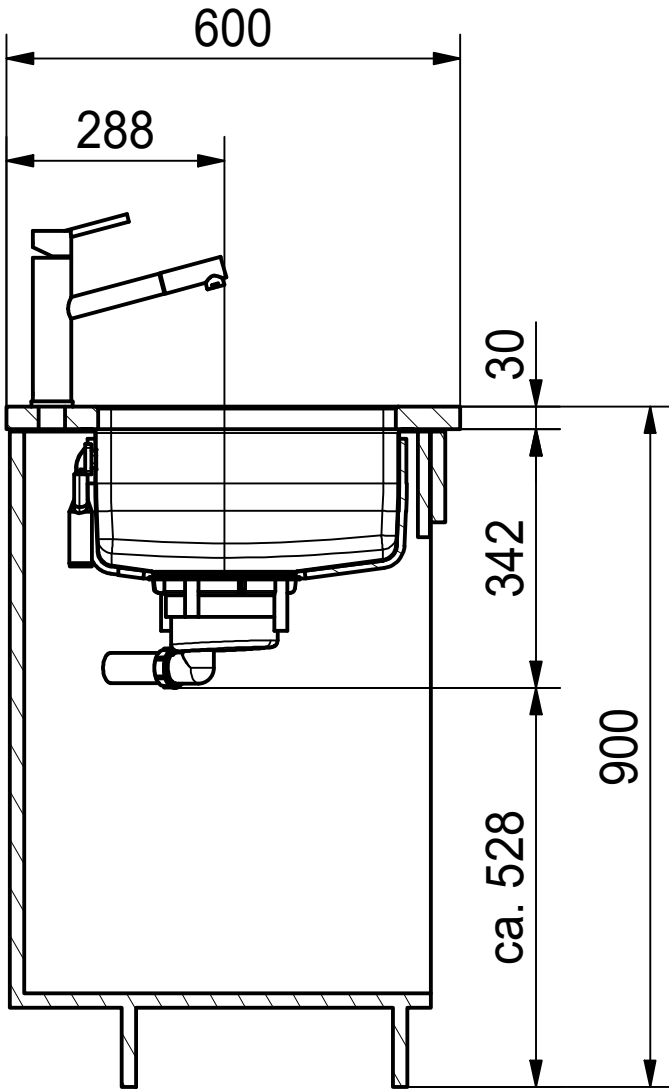

Drawing No.	20247047_01	Revision	-
Drawn Date	12.01.2023		
These drawings and specifications are the property of Franke Technology and Trademark Ltd., Hergiswil, Switzerland.			



MQX 110-50 SI
Installing Document

Sheet	Sheets
2	6

CO

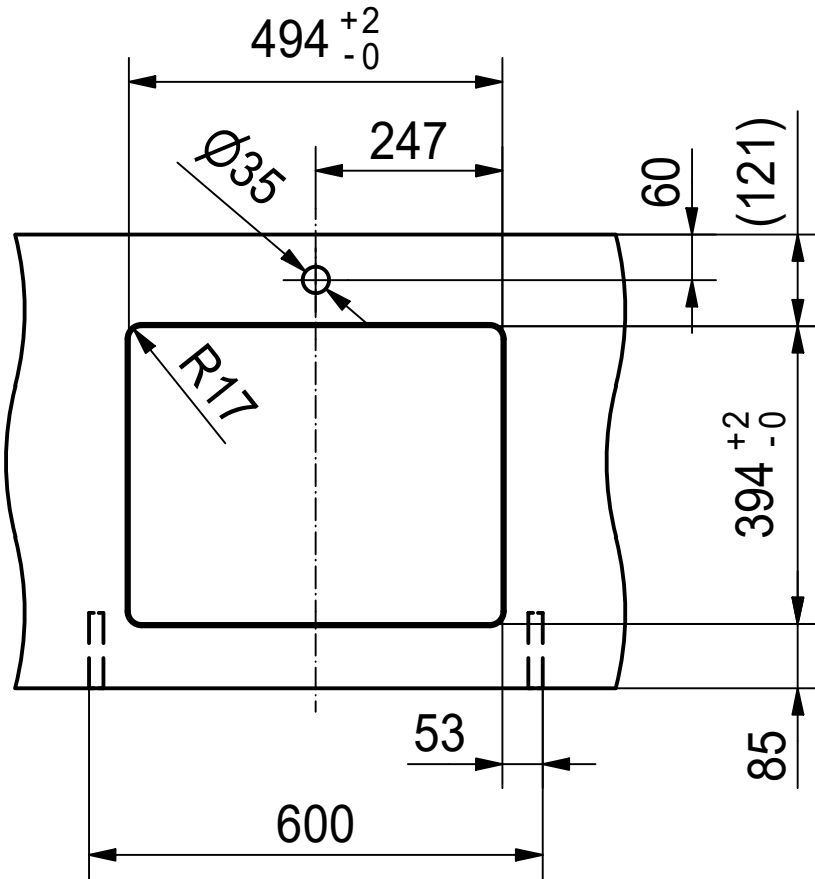

Drawing No.	20247047_01	Revision	-
Drawn Date	12.01.2023		
These drawings and specifications are the property of Franke Technology and Trademark Ltd., Hergiswil, Switzerland.			



MQX 110-50 SI
Installing Document

Sheet	Sheets
3	6

CNC



Drawing No.	20247047_01	Revision	-
Drawn Date	12.01.2023		
These drawings and specifications are the property of Franke Technology and Trademark Ltd., Hergiswil, Switzerland.			



MQX 110-50 SI
Installing Document

Sheet	Sheets
4	6

DT

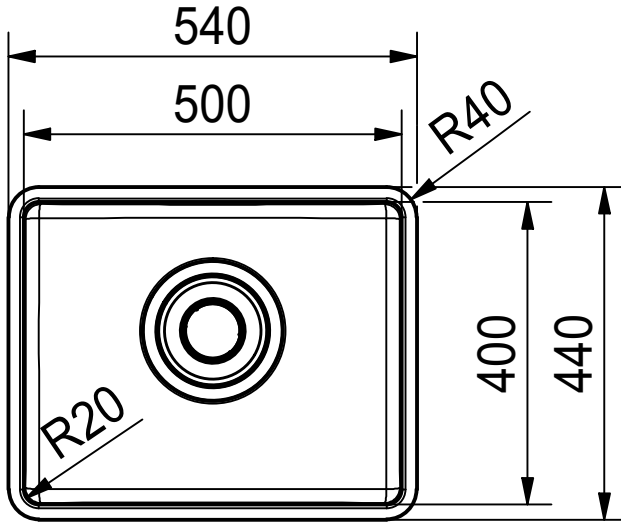

Drawing No.	20247047_01	Revision	-
Drawn Date	12.01.2023		
These drawings and specifications are the property of Franke Technology and Trademark Ltd., Hergiswil, Switzerland.			



MQX 110-50 SI
Installing Document

Sheet	Sheets
5	6

ISO

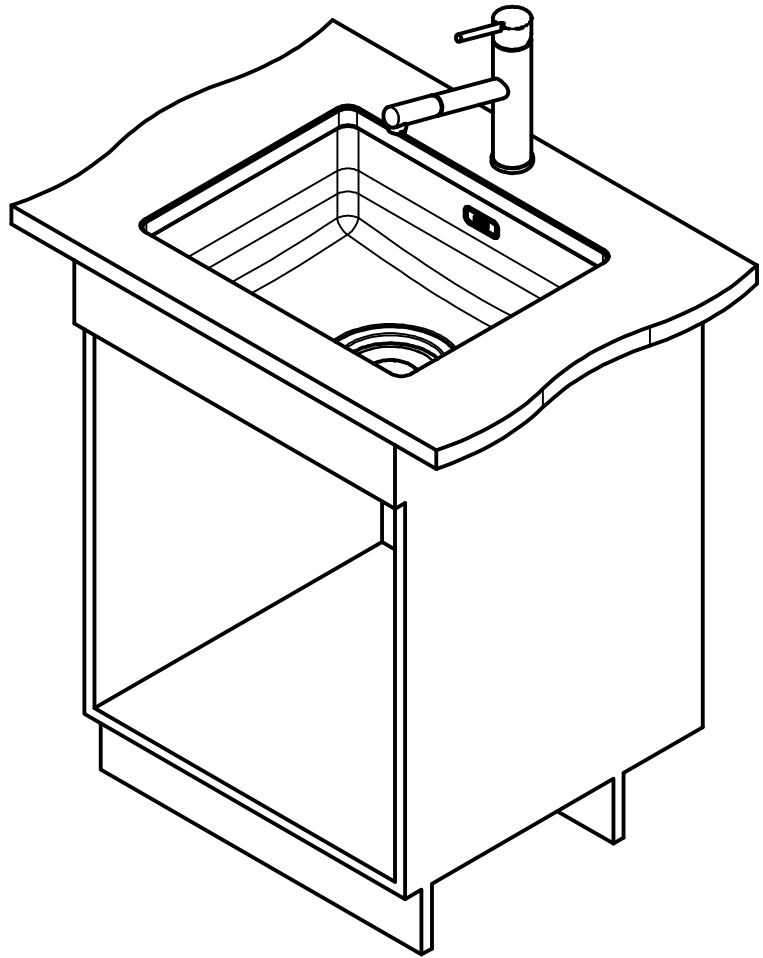

Drawing No.	20247047_01	Revision	-
Drawn Date	12.01.2023		
These drawings and specifications are the property of Franke Technology and Trademark Ltd., Hergiswil, Switzerland.			



MQX 110-50 SI
Installing Document

Sheet	Sheets
6	6