

DF

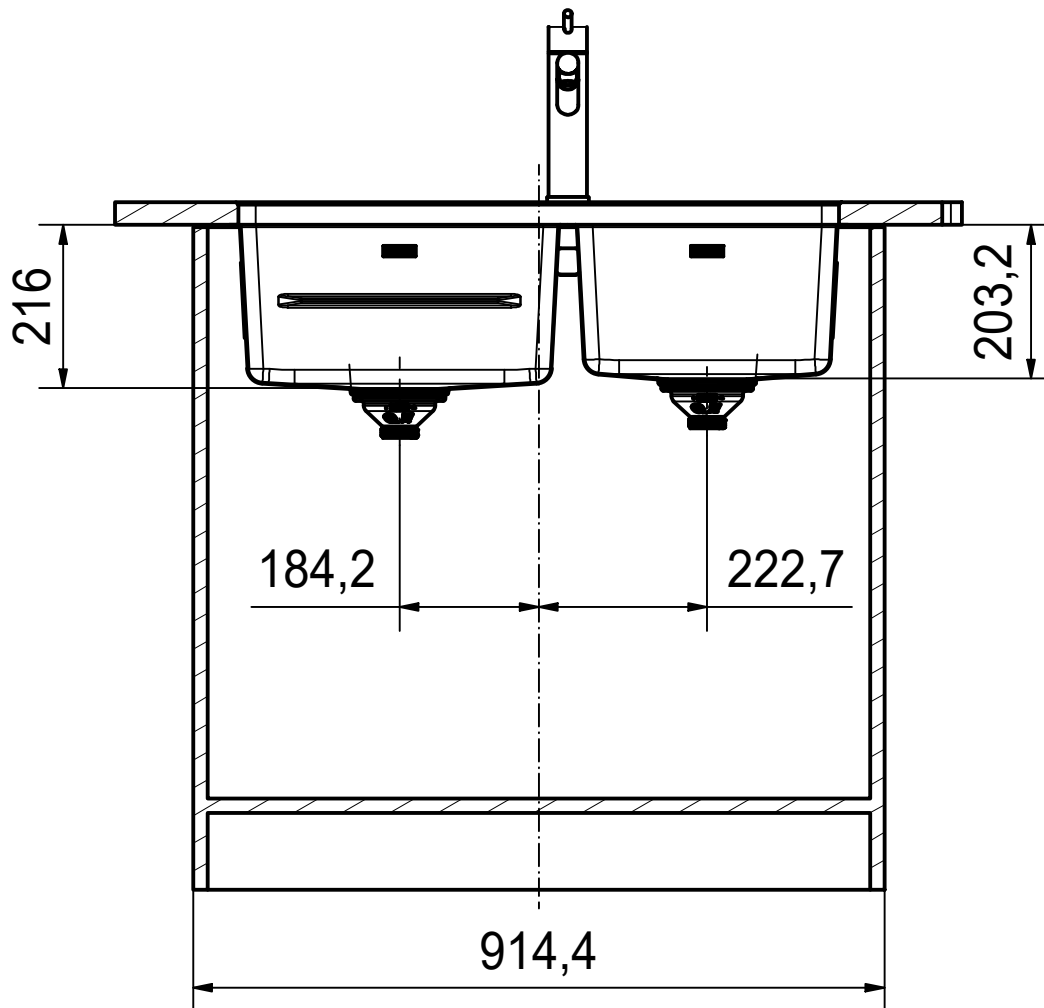

Drawing No.	20195943_01	Revision	-
Drawn Date	10.09.2020		
<small>These drawings and specifications are the property of Franke Technology and Trademark Ltd. and shall not be reproduced, copied or transferred to any third party without the prior written permission of Franke Technology and Trademark Ltd., Hergiswil, Switzerland</small>			



PTX 120-17-14" SBR SI  
installing document

Sheet	Sheets
1	6

DS

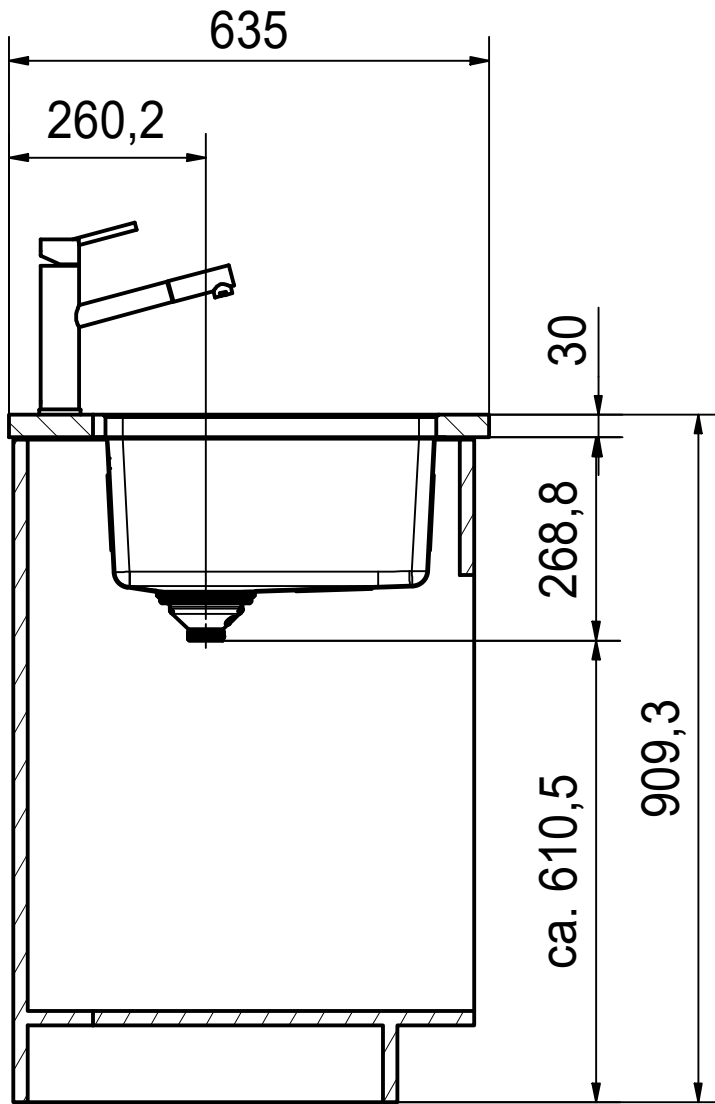

Drawing No.	20195943_01	Revision	-
Drawn Date	10.09.2020		
<small>These drawings and specifications are the property of Franke Technology and Trademark Ltd. and shall not be reproduced, copied or transferred to any third party without the prior written permission of Franke Technology and Trademark Ltd., Hergiswil, Switzerland</small>			



PTX 120-17-14" SBR SI  
installing document

Sheet	Sheets
2	6

CO

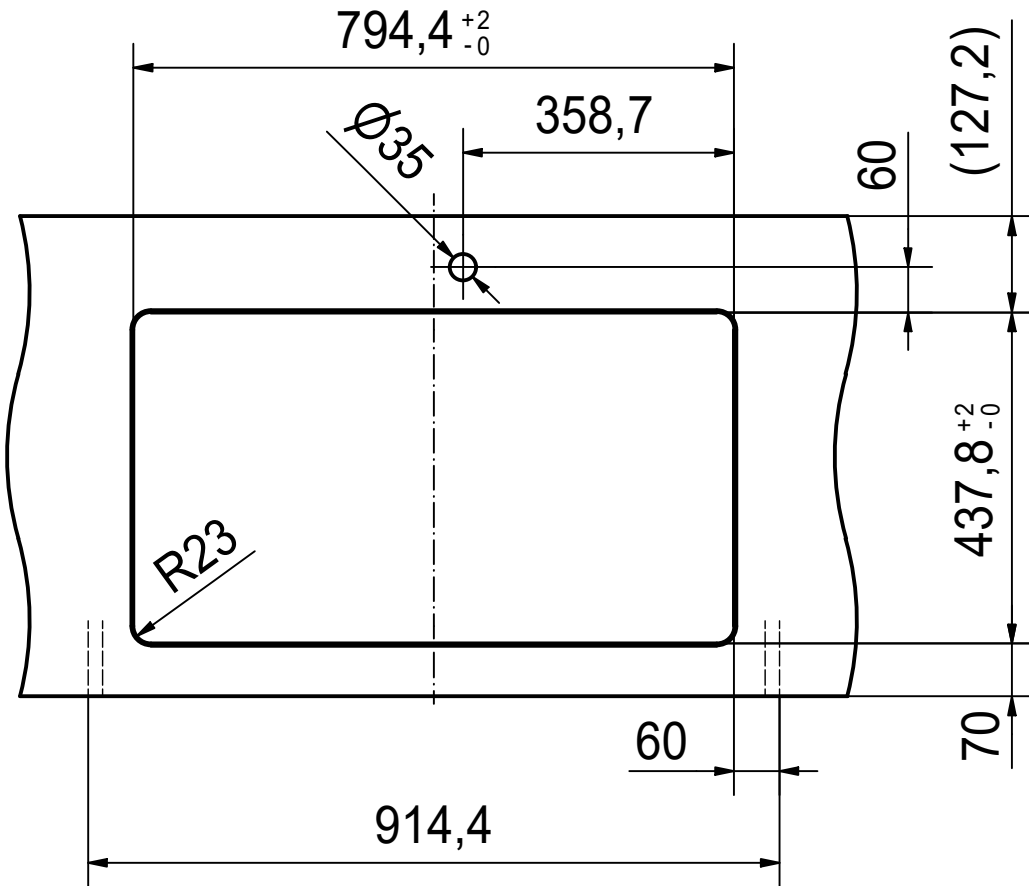

Drawing No.	20195943_01	Revision	-
Drawn Date	10.09.2020		
<small>These drawings and specifications are the property of Franke Technology and Trademark Ltd. and shall not be reproduced, copied or transferred to any third party without the prior written permission of Franke Technology and Trademark Ltd., Hergiswil, Switzerland</small>			



PTX 120-17-14" SBR SI  
installing document

Sheet	Sheets
3	6

**CNC**



Drawing No.	20195943_01	Revision	-
Drawn Date	10.09.2020		
<small>These drawings and specifications are the property of Franke Technology and Trademark Ltd. and shall not be reproduced, copied or transferred to any third party without the prior written permission of Franke Technology and Trademark Ltd., Hergiswil, Switzerland</small>			



**PTX 120-17-14" SBR SI**  
installing document

Sheet	Sheets
4	6

DT

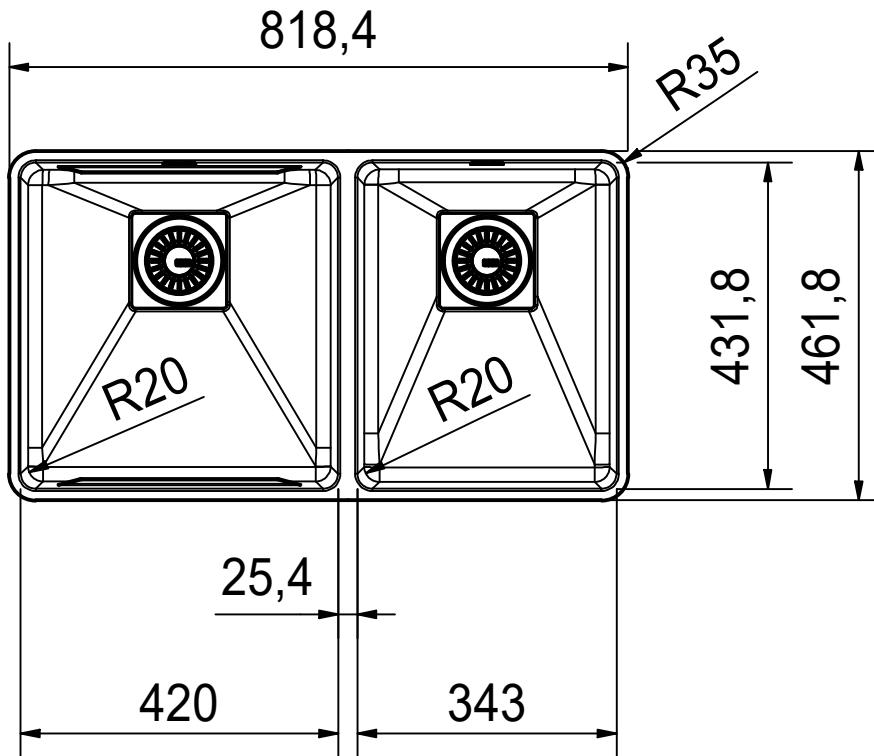

Drawing No.	20195943_01	Revision	-
Drawn Date	10.09.2020		
<small>These drawings and specifications are the property of Franke Technology and Trademark Ltd. and shall not be reproduced, copied or transferred to any third party without the prior written permission of Franke Technology and Trademark Ltd., Hergiswil, Switzerland</small>			



PTX 120-17-14" SBR SI  
installing document

Sheet	Sheets
5	6

ISO

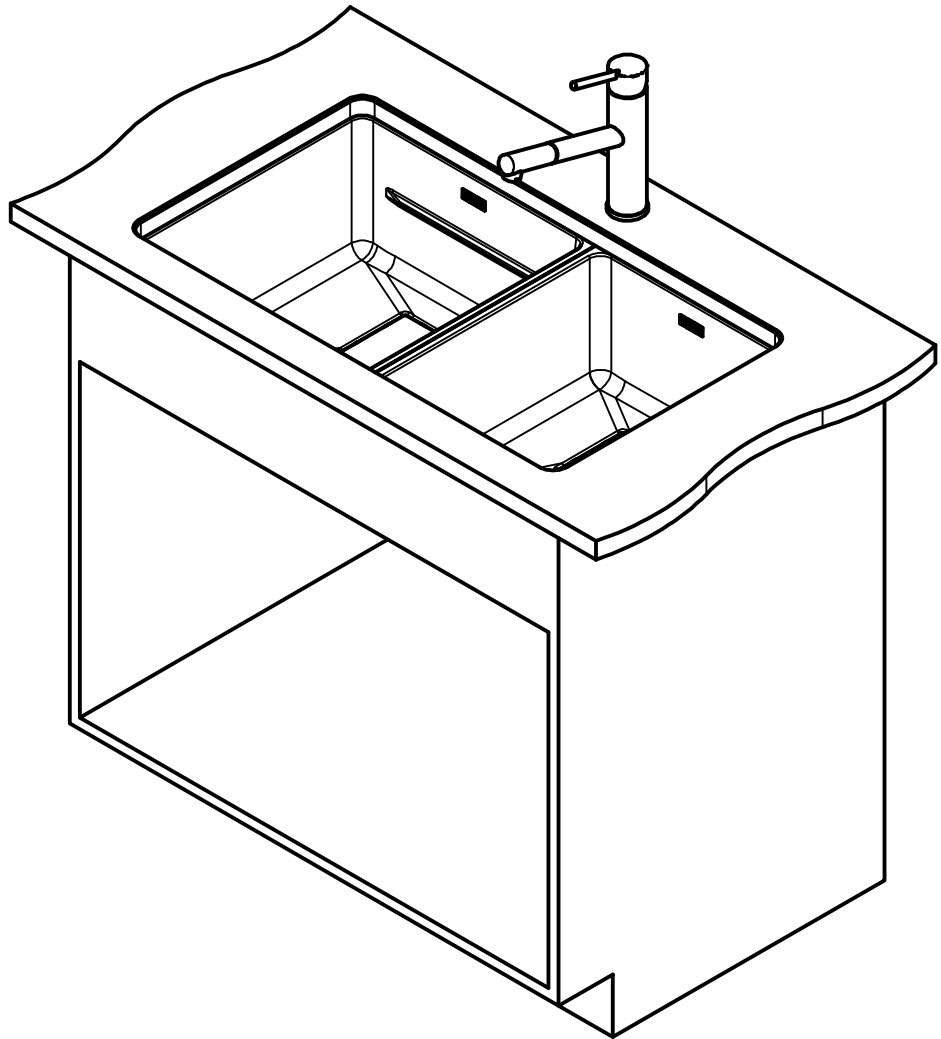

Drawing No.	20195943_01	Revision	-
Drawn Date	10.09.2020		
<small>These drawings and specifications are the property of Franke Technology and Trademark Ltd. and shall not be reproduced, copied or transferred to any third party without the prior written permission of Franke Technology and Trademark Ltd., Hergiswil, Switzerland</small>			



PTX 120-17-14" SBR SI  
installing document

Sheet	Sheets
6	6