

DF

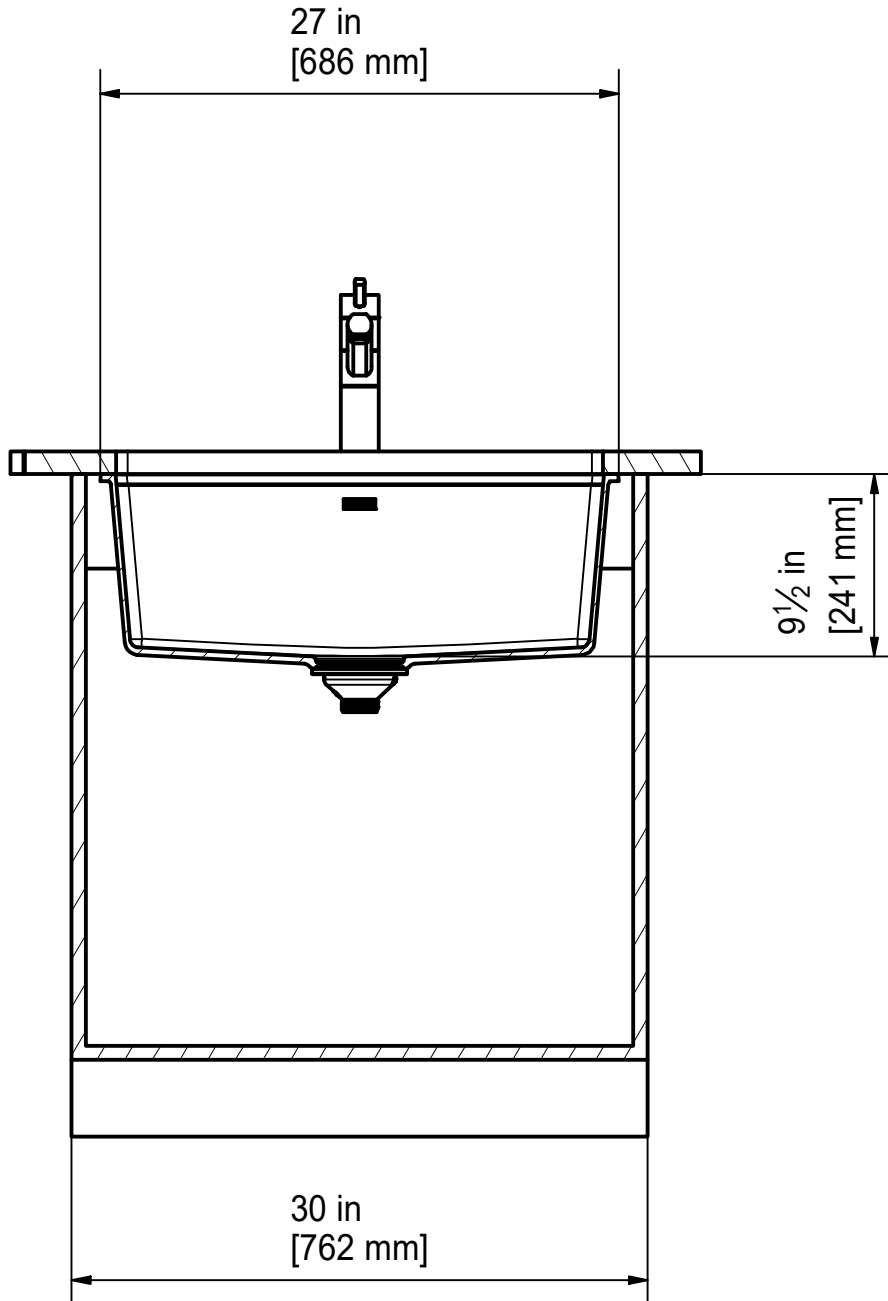

Drawing No.	20237338_02	Revision	A
Drawn Date	08.06.2022		
<small>These drawings and specifications are the property of Franke Technology and Trademark Ltd. and shall not be reproduced, copied or transferred to any third party without the prior written permission of Franke Technology and Trademark Ltd., Hergiswil, Switzerland</small>			

Franke Küchentechnik AG
CH-4663 Aarburg
Phone: +41 62 787 31 31
Internet: www.franke.com

MRG NA 110-65

Sheet	Sheets
1	7

DS

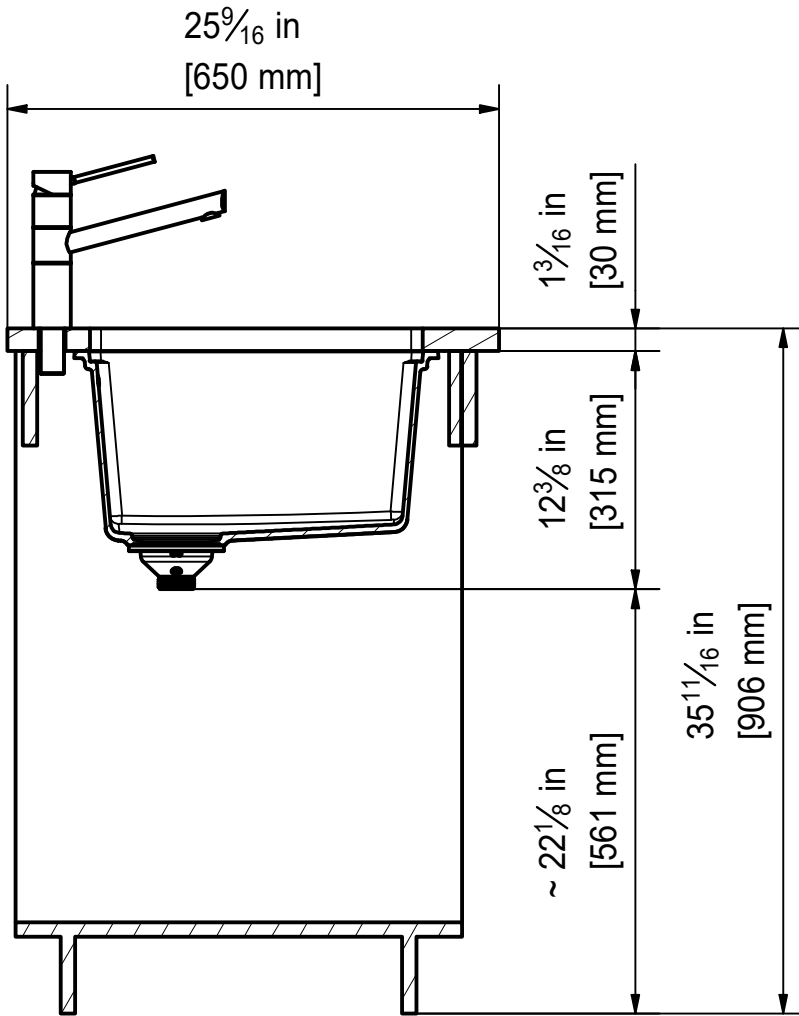

Drawing No.	20237338_02	Revision	A
Drawn Date	08.06.2022		
<small>These drawings and specifications are the property of Franke Technology and Trademark Ltd. and shall not be reproduced, copied or transferred to any third party without the prior written permission of Franke Technology and Trademark Ltd., Hergiswil, Switzerland</small>			

Franke Küchentechnik AG
CH-4663 Aarburg
Phone: +41 62 787 31 31
Internet: www.franke.com

MRG NA 110-65

Sheet	Sheets
2	7

CO

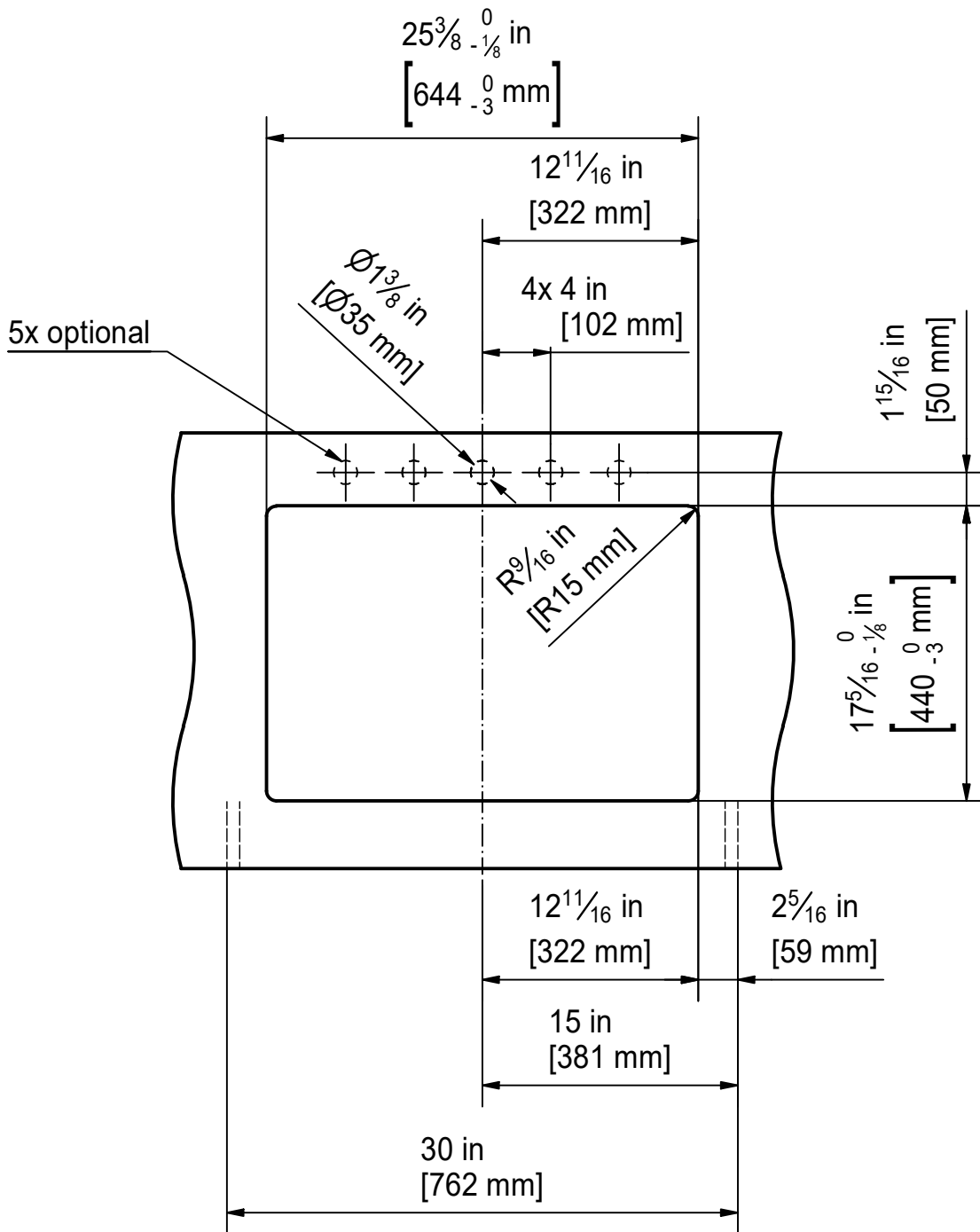

Drawing No.	20237338_02	Revision	A
Drawn Date	08.06.2022		
<small>These drawings and specifications are the property of Franke Technology and Trademark Ltd. and shall not be reproduced, copied or transferred to any third party without the prior written permission of Franke Technology and Trademark Ltd., Hergiswil, Switzerland</small>			

Franke Küchentechnik AG
 CH-4663 Aarburg
 Phone: +41 62 787 31 31
 Internet: www.franke.com

MRG NA 110-65

Sheet	Sheets
3	7

CNC



Drawing No.	20237338_02	Revision	A
Drawn Date	08.06.2022		
<small>These drawings and specifications are the property of Franke Technology and Trademark Ltd. and shall not be reproduced, copied or transferred to any third party without the prior written permission of Franke Technology and Trademark Ltd., Hergiswil, Switzerland</small>			

Franke Küchentechnik AG
CH-4663 Aarburg
Phone: +41 62 787 31 31
Internet: www.franke.com

MRG NA 110-65

Sheet	Sheets
4	7

FP

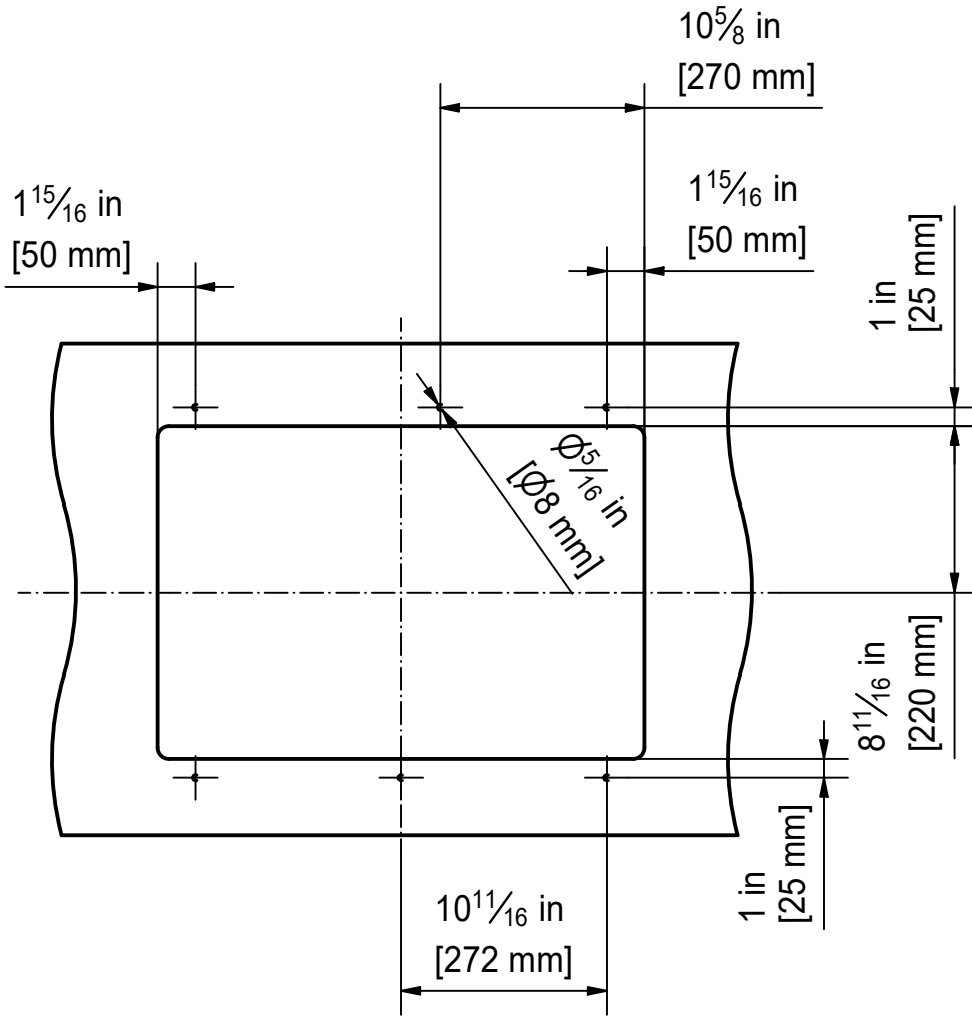

Drawing No.	20237338_02	Revision	A
Drawn Date	08.06.2022		
<small>These drawings and specifications are the property of Franke Technology and Trademark Ltd. and shall not be reproduced, copied or transferred to any third party without the prior written permission of Franke Technology and Trademark Ltd., Hergiswil, Switzerland</small>			

Franke Küchentechnik AG
 CH-4663 Aarburg
 Phone: +41 62 787 31 31
 Internet: www.franke.com

MRG NA 110-65

Sheet	Sheets
5	7

DT

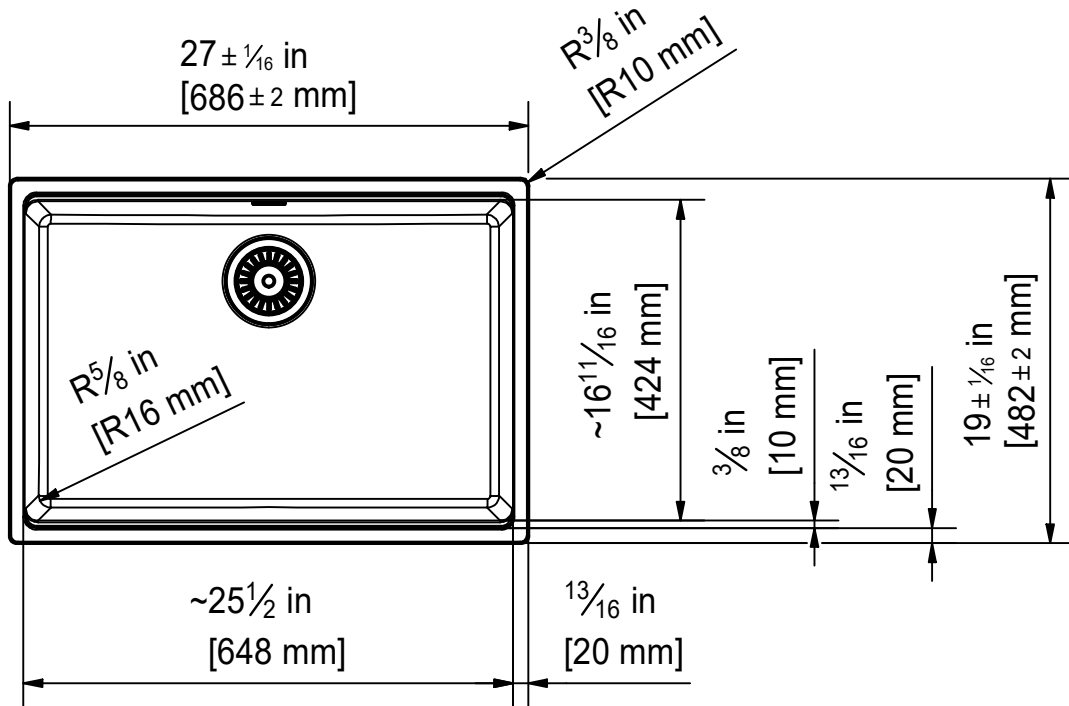

Drawing No.	20237338_02	Revision	A
Drawn Date	08.06.2022		
<small>These drawings and specifications are the property of Franke Technology and Trademark Ltd. and shall not be reproduced, copied or transferred to any third party without the prior written permission of Franke Technology and Trademark Ltd., Hergiswil, Switzerland</small>			

Franke Küchentechnik AG
CH-4663 Aarburg
Phone: +41 62 787 31 31
Internet: www.franke.com

MRG NA 110-65

Sheet	Sheets
6	7

ISO

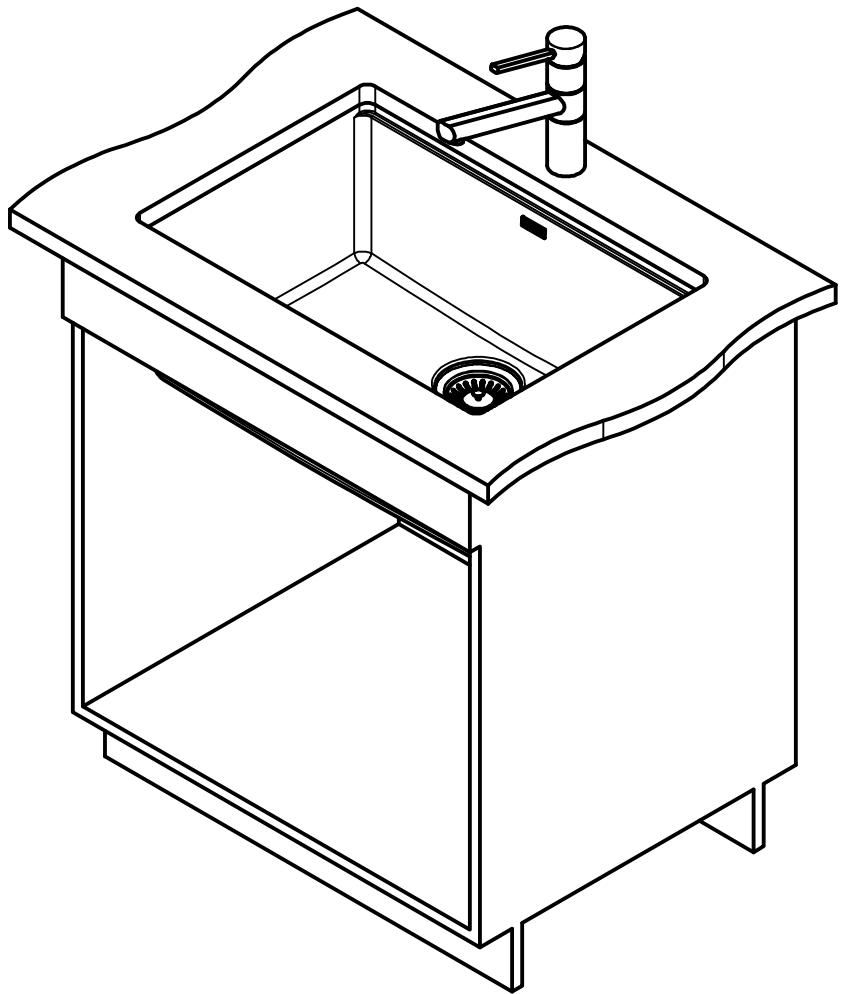

Drawing No.	20237338_02	Revision	A
Drawn Date	08.06.2022		
<small>These drawings and specifications are the property of Franke Technology and Trademark Ltd. and shall not be reproduced, copied or transferred to any third party without the prior written permission of Franke Technology and Trademark Ltd., Hergiswil, Switzerland</small>			

Franke Küchentechnik AG
CH-4663 Aarburg
Phone: +41 62 787 31 31
Internet: www.franke.com

MRG NA 110-65

Sheet	Sheets
7	7