

DF

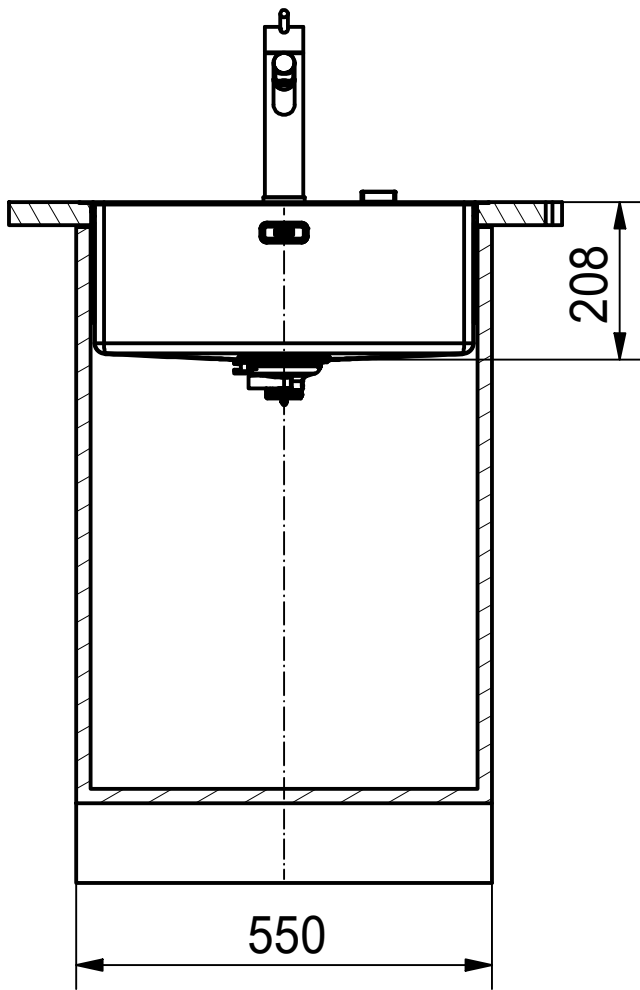

Drawing No.	20119927	Revision	B
Drawn Date	20.03.2015		
<small>These drawings and specifications are the property of Franke Technology and Trademark Ltd. and shall not be reproduced, copied or transferred to any third party without the prior written permission of Franke Technology and Trademark Ltd., Hergiswil, Switzerland</small>			

Franke Küchentechnik AG  
CH-4663 Aarburg  
Phone: +41 62 787 31 31  
Internet: www.franke.com

**BXX 210\_110 50**  
Installing document

Sheet	Sheets
1	11

DS

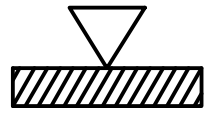
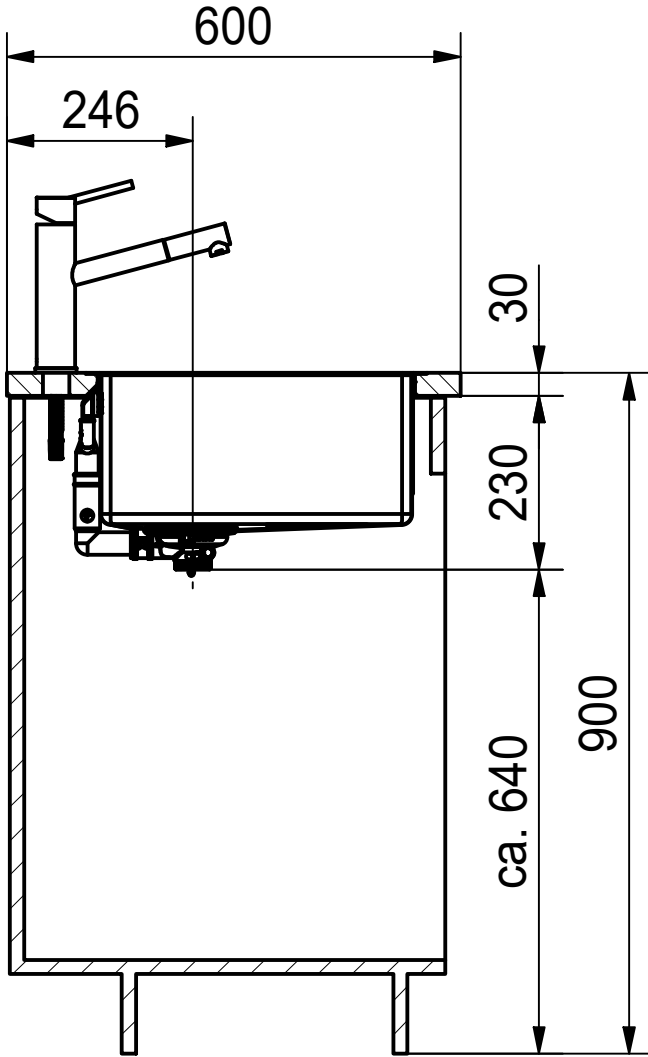

Drawing No.	20119927	Revision	B
Drawn Date	20.03.2015		
<small>These drawings and specifications are the property of Franke Technology and Trademark Ltd. and shall not be reproduced, copied or transferred to any third party without the prior written permission of Franke Technology and Trademark Ltd., Hergiswil, Switzerland</small>			

Franke Küchentechnik AG  
CH-4663 Aarburg  
Phone: +41 62 787 31 31  
Internet: www.franke.com

**BXX 210\_110 50**  
Installing document

Sheet	Sheets
2	11

CO

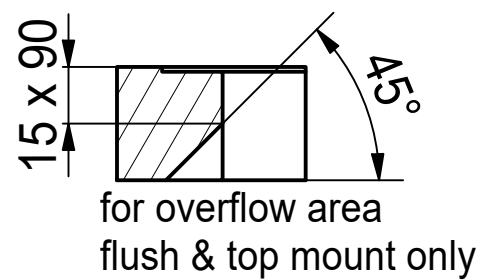
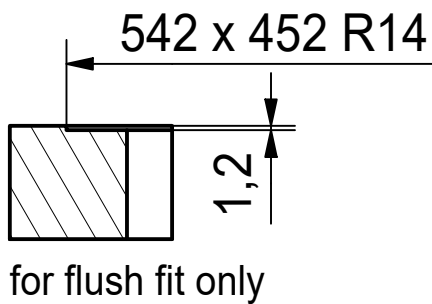
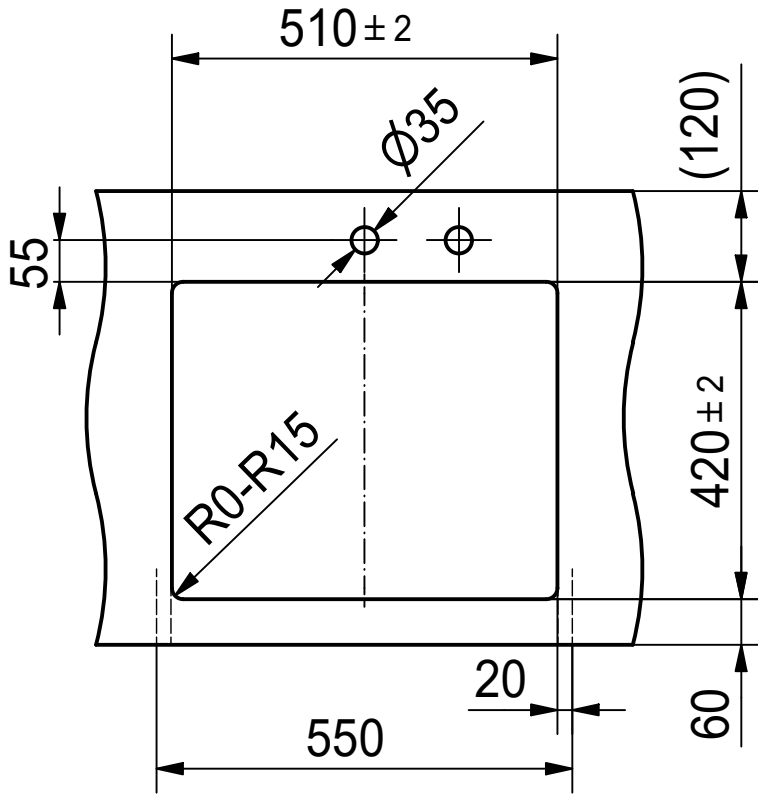

Drawing No.	20119927	Revision	B
Drawn Date	20.03.2015		
<small>These drawings and specifications are the property of Franke Technology and Trademark Ltd. and shall not be reproduced, copied or transferred to any third party without the prior written permission of Franke Technology and Trademark Ltd., Hergiswil, Switzerland</small>			

Franke Küchentechnik AG  
 CH-4663 Aarburg  
 Phone: +41 62 787 31 31  
 Internet: www.franke.com

**BXX 210\_110 50**  
 Installing document

Sheet	Sheets
3	11

**CNC**



Drawing No.	20119927	Revision	B
Drawn Date	20.03.2015		
<small>These drawings and specifications are the property of Franke Technology and Trademark Ltd. and shall not be reproduced, copied or transferred to any third party without the prior written permission of Franke Technology and Trademark Ltd., Hergiswil, Switzerland</small>			

Franke Küchentechnik AG  
CH-4663 Aarburg  
Phone: +41 62 787 31 31  
Internet: www.franke.com

**BXX 210\_110 50**  
Installing document

Sheet	Sheets
<b>4</b>	<b>11</b>

DT

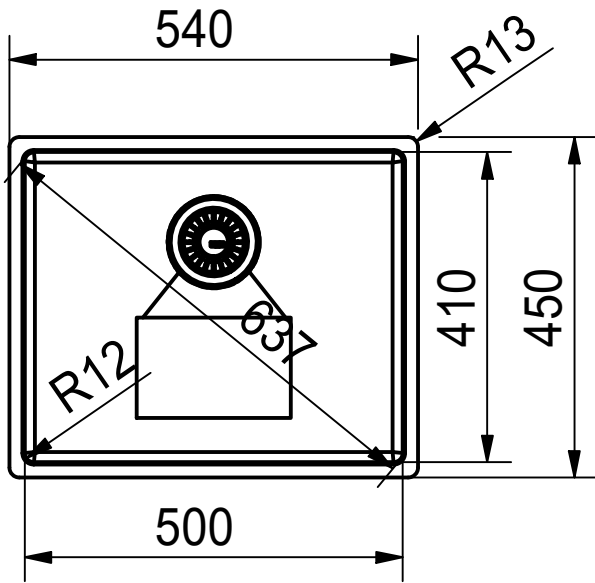

Drawing No.	20119927	Revision	B
Drawn Date	20.03.2015		
<small>These drawings and specifications are the property of Franke Technology and Trademark Ltd. and shall not be reproduced, copied or transferred to any third party without the prior written permission of Franke Technology and Trademark Ltd., Hergiswil, Switzerland</small>			

Franke Küchentechnik AG  
CH-4663 Aarburg  
Phone: +41 62 787 31 31  
Internet: www.franke.com

**BXX 210\_110 50**  
Installing document

Sheet	Sheets
5	11

ISO

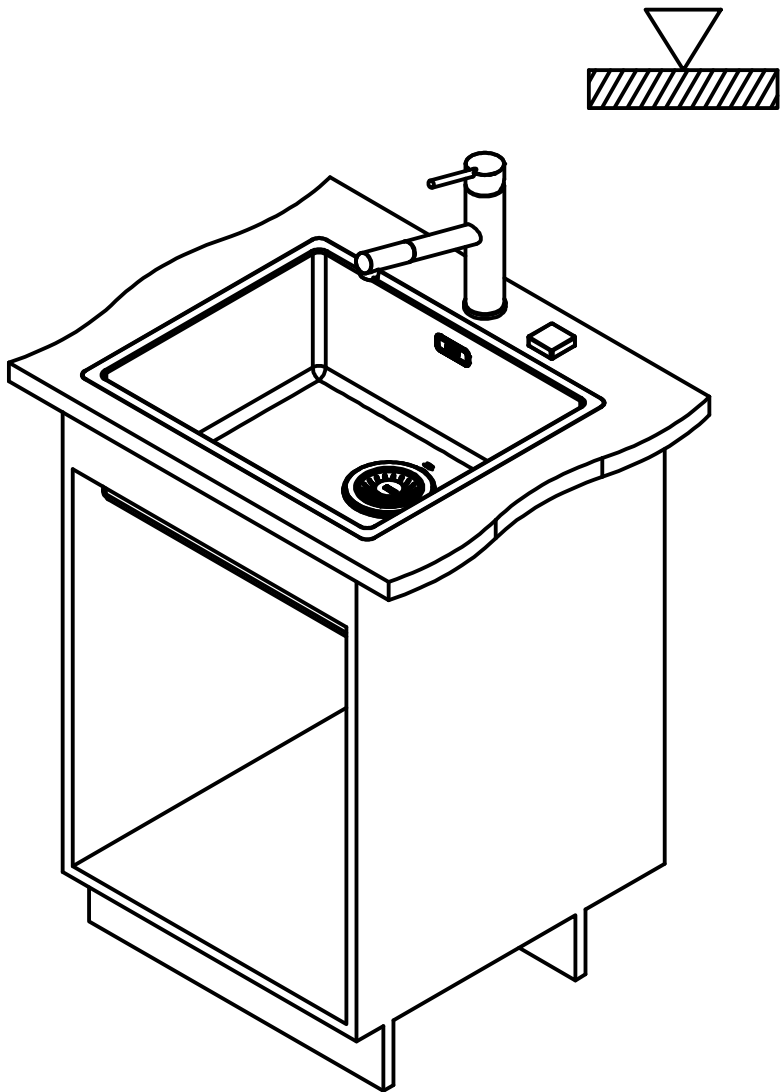

Drawing No.	20119927	Revision	B
Drawn Date	20.03.2015		
<small>These drawings and specifications are the property of Franke Technology and Trademark Ltd. and shall not be reproduced, copied or transferred to any third party without the prior written permission of Franke Technology and Trademark Ltd., Hergiswil, Switzerland</small>			

Franke Küchentechnik AG  
CH-4663 Aarburg  
Phone: +41 62 787 31 31  
Internet: www.franke.com

**BXX 210\_110 50**  
Installing document

Sheet	Sheets
<b>6</b>	<b>11</b>

DF

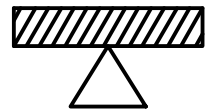
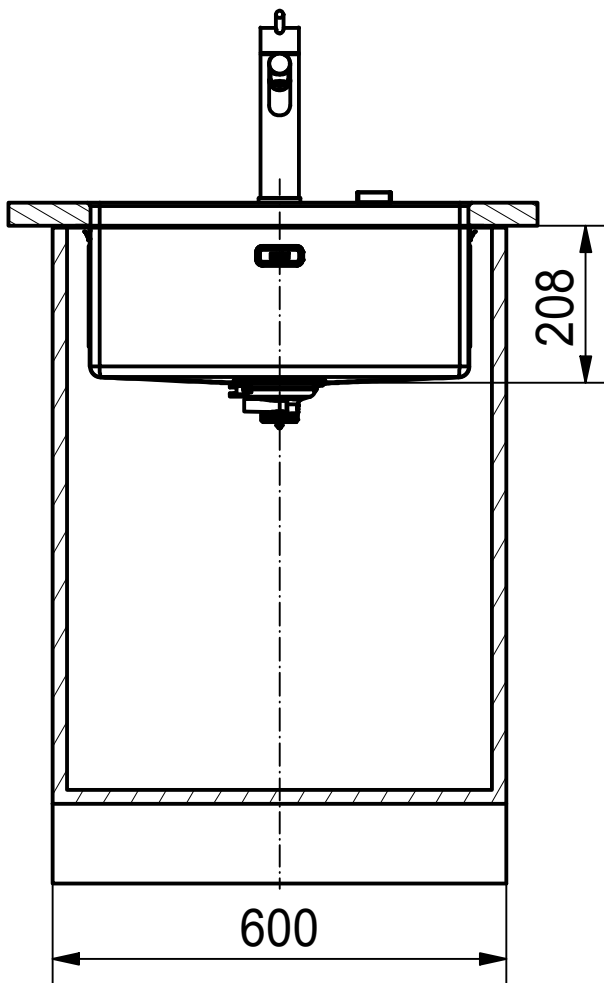

Drawing No.	20119927	Revision	B
Drawn Date	20.03.2015		
<small>These drawings and specifications are the property of Franke Technology and Trademark Ltd. and shall not be reproduced, copied or transferred to any third party without the prior written permission of Franke Technology and Trademark Ltd., Hergiswil, Switzerland</small>			

Franke Küchentechnik AG  
CH-4663 Aarburg  
Phone: +41 62 787 31 31  
Internet: www.franke.com

**BXX 210\_110 50**  
Installing document

Sheet	Sheets
7	11

DS

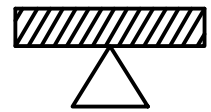
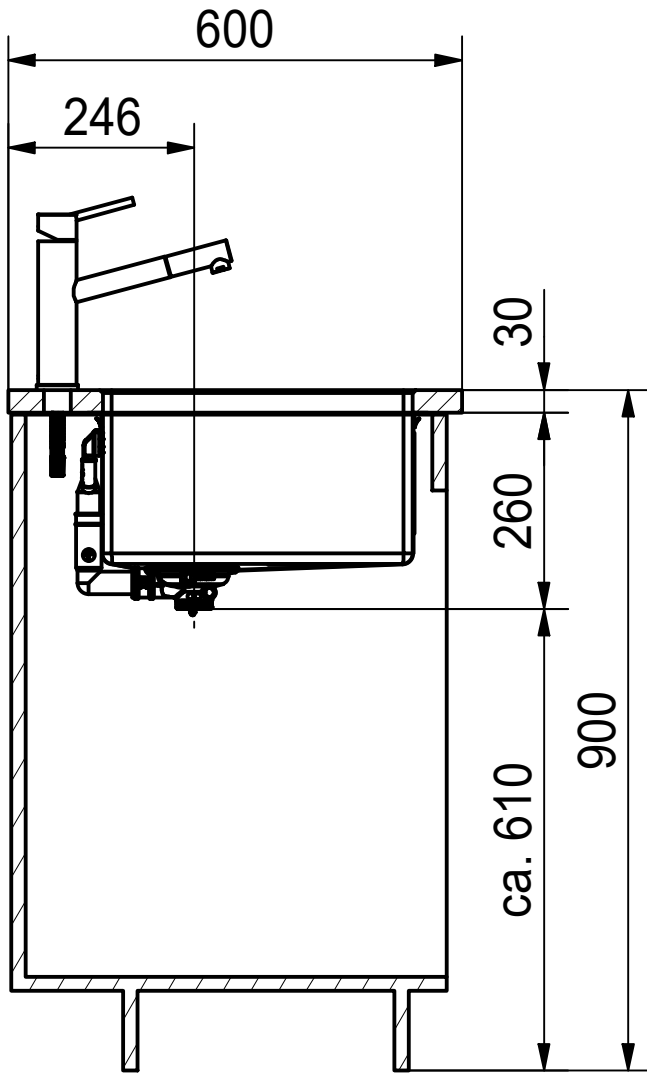

Drawing No.	20119927	Revision	B
Drawn Date	20.03.2015		
<small>These drawings and specifications are the property of Franke Technology and Trademark Ltd. and shall not be reproduced, copied or transferred to any third party without the prior written permission of Franke Technology and Trademark Ltd., Hergiswil, Switzerland</small>			

Franke Küchentechnik AG  
CH-4663 Aarburg  
Phone: +41 62 787 31 31  
Internet: www.franke.com

**BXX 210\_110 50**  
Installing document

Sheet	Sheets
8	11



CO

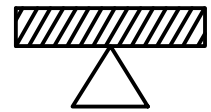
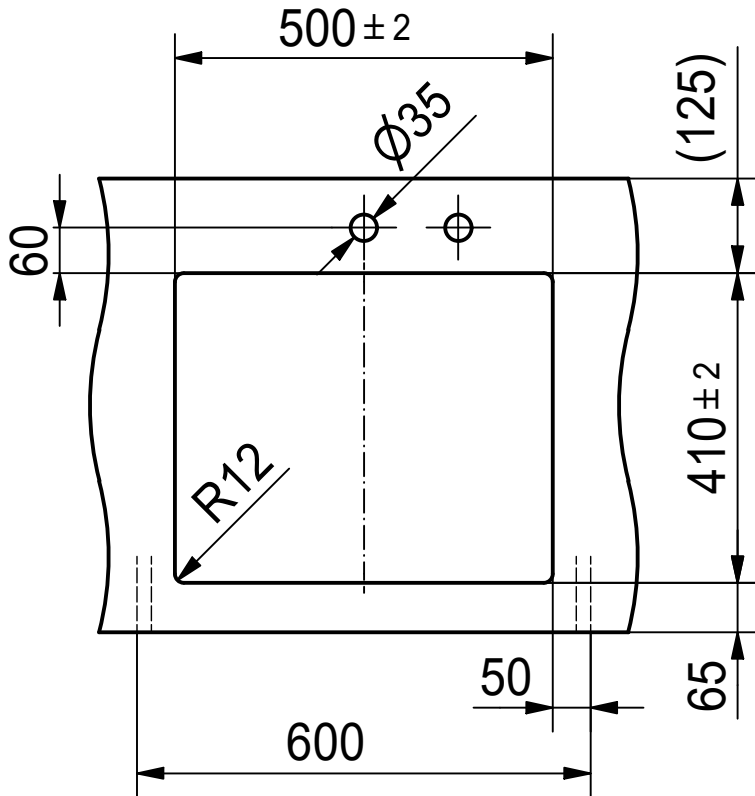

Drawing No.	20119927	Revision	B
Drawn Date	20.03.2015		
<small>These drawings and specifications are the property of Franke Technology and Trademark Ltd. and shall not be reproduced, copied or transferred to any third party without the prior written permission of Franke Technology and Trademark Ltd., Hergiswil, Switzerland</small>			

Franke Küchentechnik AG  
CH-4663 Aarburg  
Phone: +41 62 787 31 31  
Internet: www.franke.com

**BXX 210\_110 50**  
Installing document

Sheet	Sheets
9	11

**CNC**

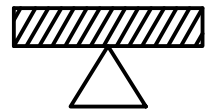

Drawing No.	20119927	Revision	B
Drawn Date	20.03.2015		
<small>These drawings and specifications are the property of Franke Technology and Trademark Ltd. and shall not be reproduced, copied or transferred to any third party without the prior written permission of Franke Technology and Trademark Ltd., Hergiswil, Switzerland</small>			

Franke Küchentechnik AG  
CH-4663 Aarburg  
Phone: +41 62 787 31 31  
Internet: www.franke.com

**BXX 210\_110 50**  
Installing document

Sheet	Sheets
<b>10</b>	<b>11</b>

ISO

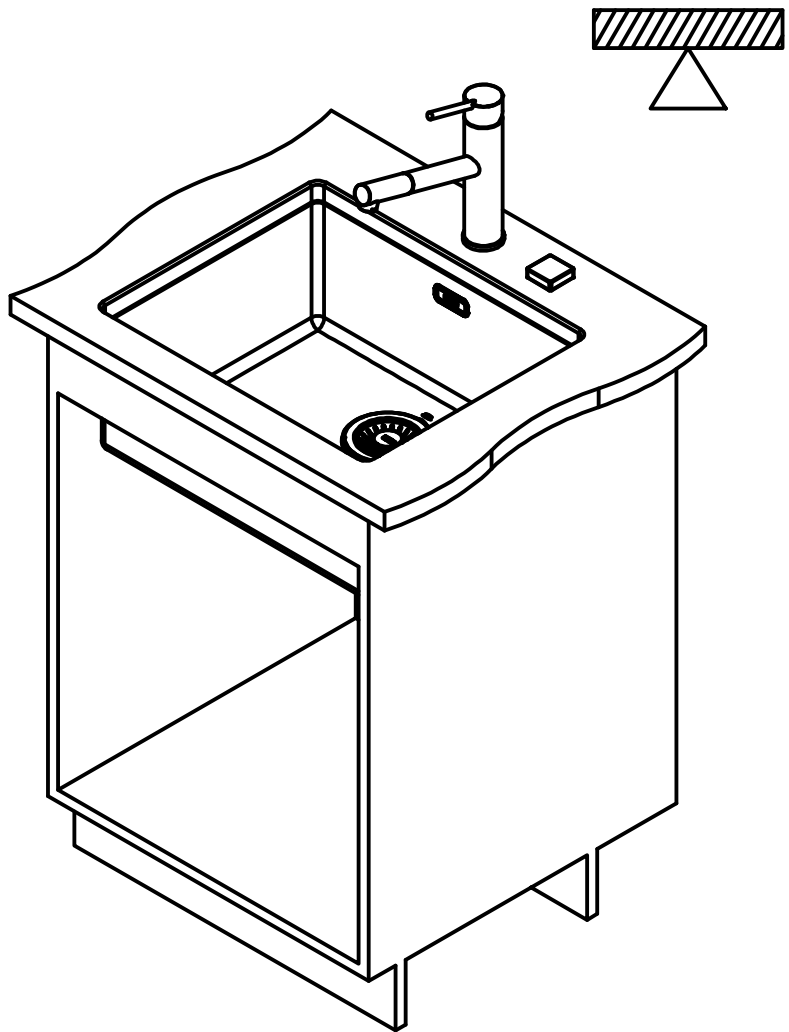

Drawing No.	20119927	Revision	B
Drawn Date	20.03.2015		
<small>These drawings and specifications are the property of Franke Technology and Trademark Ltd. and shall not be reproduced, copied or transferred to any third party without the prior written permission of Franke Technology and Trademark Ltd., Hergiswil, Switzerland</small>			

Franke Küchentechnik AG  
CH-4663 Aarburg  
Phone: +41 62 787 31 31  
Internet: www.franke.com

**BXX 210\_110 50**  
Installing document

Sheet	Sheets
<b>11</b>	<b>11</b>